

Ponderosa

OFFICE CENTER

3080 Olcott Street, Santa Clara, CA



±625 - ±981 RSF Available

Derek Yep | dyep@ngkf.com
408.987.4106 | Lic# 01476099

Tom Sweeney | tsweeney@ngkf.com
408.982.8493 | Lic# 00989779



**Newmark
Knight Frank**

Ponderosa

OFFICE CENTER 3080 Olcott Street, Santa Clara, CA

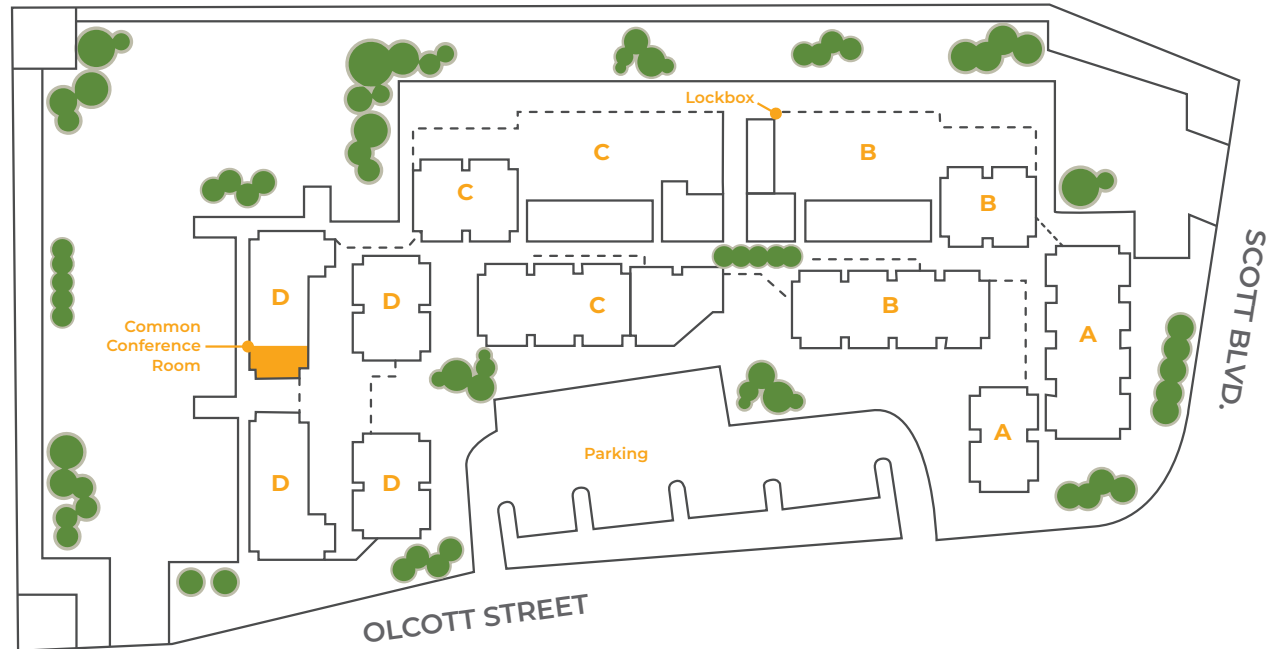

AVAILABILITIES

Suite	Size
Suite B108	±625 RSF (Available May 1, 2020)
Suite C220	±655 RSF (Available April 1, 2020)
Suite A125	±789 RSF (Available June 1, 2020)
Suite D230	±855 RSF (Available May 1, 2020)
Suite D220	±981 RSF

Ponderosa

OFFICE CENTER 3080 Olcott Street, Santa Clara, CA



PROJECT HIGHLIGHTS / LOCATION

- Upgraded Bathrooms
- AT&T Business Fiber Available
- Serene, Park-Like Setting
- Suites with Decks, Patios
- Immediate Freeway Access to 101 and Central Expressway
- Close Proximity to San Jose Airport
- Nearby Amenities (Hotel, Restaurants, Retail)
- Furnished Conference Room
- Creekside Exercise Path
- Lush Landscaping

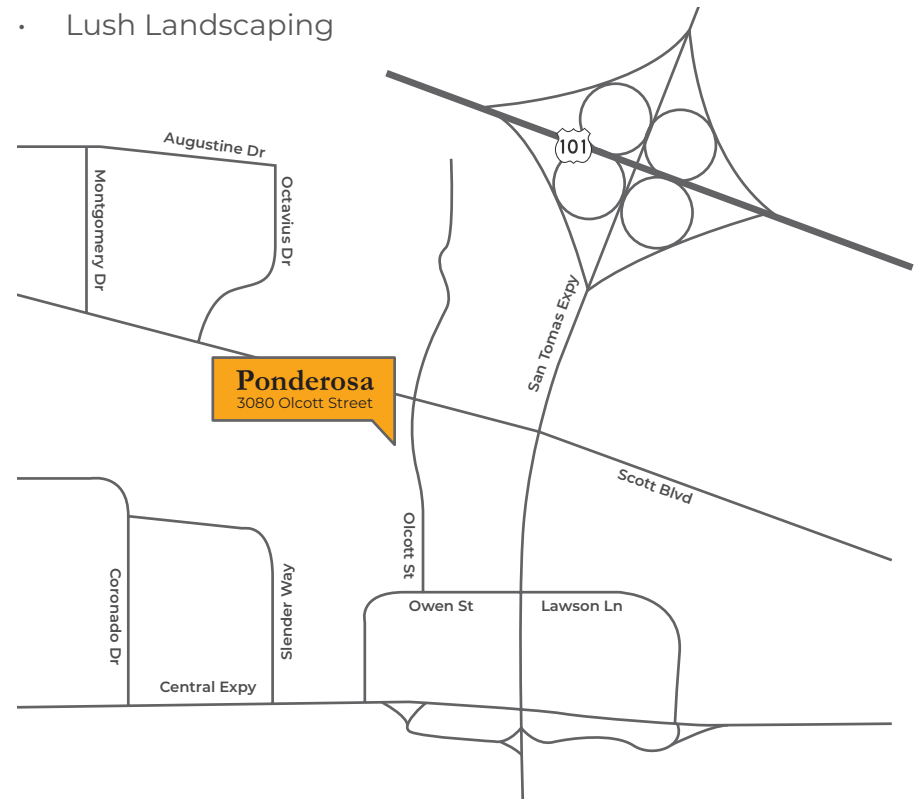

Ponderosa

OFFICE CENTER 3080 Olcott Street, Santa Clara, CA

Suite B108

±625 RSF (Available May 1, 2020)

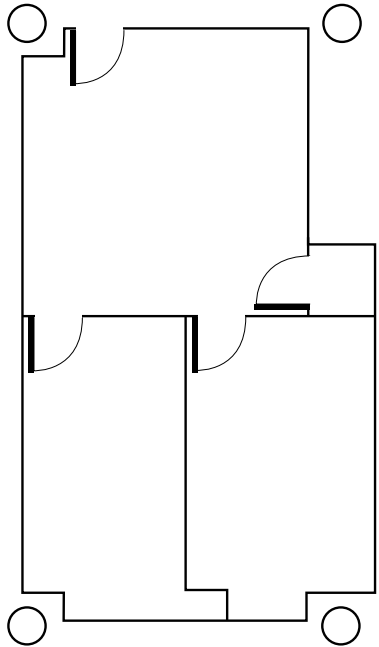

Suite C220

± 655 RSF (Available April 1, 2020)

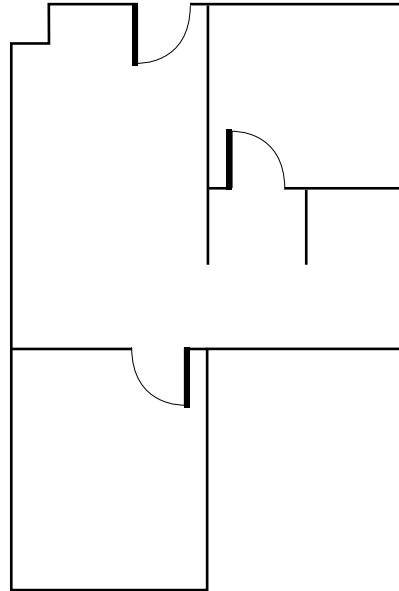

Suite D230

±855 RSF (Available May 1, 2020)

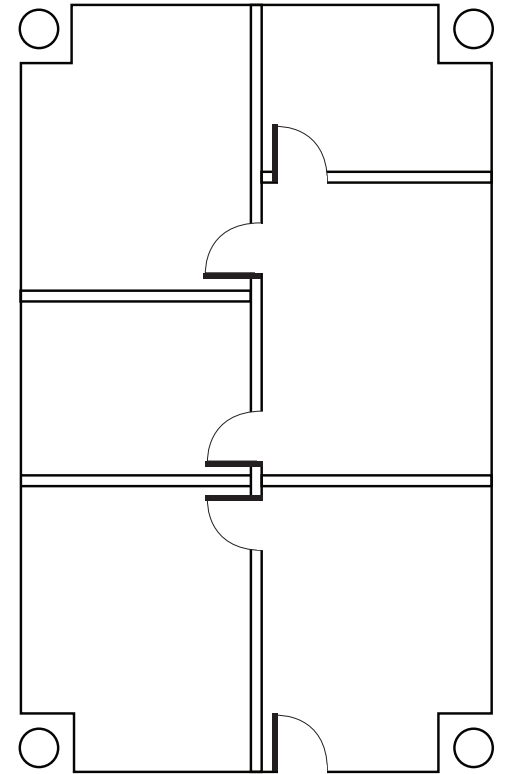

Ponderosa

OFFICE CENTER 3080 Olcott Street, Santa Clara, CA

Suite A125

±789 RSF (Available June 1, 2020)

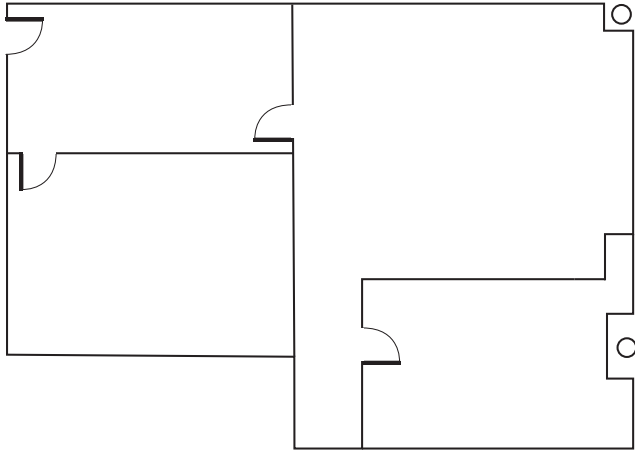

Suite D220

±981 RSF

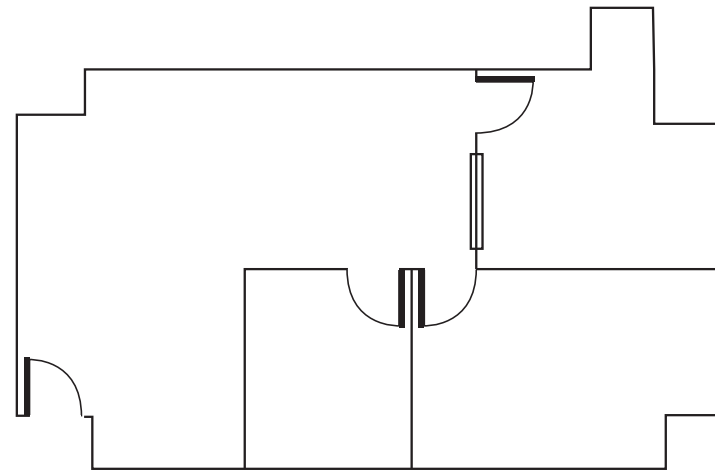

Ponderosa

OFFICE CENTER 3080 Olcott Street, Santa Clara, CA



RESTAURANTS

1 Santa Clara Square

- Whole Foods
- Opa!
- Flemings Steakhouse
- Il Fornaio
- Specialtys

2 McDonalds

3 Jack-in-the-Box

4 Sizzler

5 Parcel 104

6 Birks

7 IHOP

8 Prime 109

3 Mercado Center

- Jamba Juice
- Starbucks
- Mexicali Grill
- Tomatina

• In-N-Out

• AMC Theaters

10 Rivermark Plaza

• Piattis

• Premier Pizza

• Safeway

• Prolific Oven

• Red Robin

• Peet's Coffee

• Mezbaan Indian Cuisine

• Baja Fresh

HOTELS

1 Embassy Suites

2 Avatar Hotel

3 Marriot

4 Hilton

5 Hyatt

6 Biltmore

The distributor of this communication is performing acts for which a real estate license is required. The information contained herein has been obtained from sources deemed reliable but has not been verified and no guarantee, warranty or representation, either express or implied, is made with respect to such information. Terms of sale or lease and availability are subject to change or withdrawal without notice. 3055 Olin Avenue, Suite 2200, San Jose, CA 95128 | 08-2537 · 02/20

Derek Yep
 dyep@ngkf.com
 408.987.4106
 CA RE Lic #01476099

Tom Sweeney
 tsweeney@ngkf.com
 408.982.8493
 CA RE Lic #00989779



Newmark Knight Frank